



***Century***  
***125ie***  
***EURO 5***



MANUEL DE PROPRIÉTAIRE  
OWNER'S MANUAL  
MANUAL DEL PROPIETARIO

Bienvenu! welcome! Bienvenido!



\*GARANTIE CONSTRUCTEUR DE 2 ANS (PIÈCES ET MAIN D'OEUVRE). **TWO YEARS OF WARRANTY (PARTS AND MANPOWER).** DOS AÑOS DE GARANTIA (M.O.Y PIEZAS).



**RIEJU S.A.** is grateful for the confidence you have put in their company and would like to congratulate you on your choice of motorbike.

The **Century 125ie Euro5** are the result of the long-term experience that **RIEJU** has had in competitions, which has led to the development of a high performance vehicle.

The objective of this owner's manual is to denote the use and maintenance of your vehicle, we ask you to read the instructions and information that follow carefully.

We wish to remind you that the life of the vehicle depends on how it is maintained. Maintaining the vehicle in perfect working condition reduces the cost of repair.

This manual has to be considered as an integral component of the motorbike and must remain part of the basic equipment, and handed over in the event of a change of vehicle ownership.

In the event of any problems, please consult the RIEJU dealer who will assist you or check our web [www.riejumoto.com](http://www.riejumoto.com).

Please remember that for your motorbike to perform correctly, **you should always fit original spare parts.**



## CONTENTS

MOTORBIKE DESCRIPTION .....	6	Rear brake .....	15
DELIVERY OF THE MOTORCYCLE .....	7	Brake fluid level and brake pad wear .....	15
IDENTIFICATION OF THE MOTORBIKE .....	9	Throttle twist grip .....	16
ENGINE IDENTIFICATION NUMBER .....	9	Lights, indicators and warning lamps .....	16
MAIN ELEMENTS OF THE MOTORBIKE .....	10	Start switch .....	16
KEYS .....	10	Tyres .....	17
HANDLE BAR SWITCHES .....	10	INSTRUMENT AND INDICATORS .....	18
Indicator Switch .....	10	Speedometer (Kmh and Mph) .....	18
Horn button .....	11	Out of gear (Neutral) indicator .....	18
Main and dip beam light switch .....	11	Temperature warning lamp .....	18
CLUTCH LEVER .....	12	Headlight Main beam light .....	18
FRONT BRAKE LEVER .....	12	Fuel lamp .....	19
REAR BRAKE PEDAL .....	12	Direction indicator warning lamp .....	19
GEAR BOX PEDAL .....	13	Engine warning lamp .....	19
PETROL TANK .....	13	Oil Pressure Warning lamp .....	19
ROUTINE TESTING .....	14	MOTORBIKE OPERATION .....	20
Front brake .....	14	STARTING AND RIDING .....	20



RUNNING IN.....	21
ACCELERATION.....	21
TO BRAKE (SLOWING DOWN).....	22
STOPPING.....	22
GEAR BOX PEDAL.....	22
FRONT SUSPENSION.....	23
REAR SUSPENSION.....	23
COOLING SYSTEM.....	24
CHECKING & FILLING THE ENGINE OIL LEVEL.....	25
CHAIN ADJUSTMENT AND TENSION.....	26
CLEANING AND STORAGE.....	27
CLEANING.....	27
LONG-TIME STORAGE.....	28
CHECKS BEFORE USING MOTORCYCLE.....	29
TECHNICAL SPECIFICATIONS & CHARACTERISTICS.....	30
MAINTENANCE.....	32



## MOTORBIKE DESCRIPTION

This motorbike has a 124c.c. single cylinder; liquid cooled four stroke motor. With a piston diameter of 47,0 mm and it has a 58,0 mm bore.

The motor has an ignition electronic system, and a high-tension coil.

Engine power is delivered to final drive chain via a Multiple metal clutch with constant pressure springs, submerged in an oil bath.

The engine is anchored to a highly resistant chassis, with tapered steering bearings.

The front suspension in the Century 125 ie consists of a hydraulic fork with bars, The rear suspension with variable transmission consists of two shock absorbers with variable transmission also incorporate a gas shock absorber with spring preload adjustment.

The front and rear brakes use a disk made of stainless steel and radial calliper on front brake and floating calliper on rear brake.



## **DELIVERY OF THE MOTORCYCLE** (PRE DELIVERY INSPECTION & HANDOVER)

**USER MANUAL** – very important this explains in detail the essential functions of the motorcycle, safe use and important maintenance practices.

**WARRANTY REGISTRATION** – complete the necessary information, pass a copy to the owner, and return a copy immediately to your **RIEJU** distributor.

**OPERATION** - Explain the functions & correct handling of the motorcycle.

**WARNINGS** - Explain the importance of warning labels to ensure a long life of the motorcycle.

**KEYS** - Deliver the full set and recommend making a note of the key item reference.

**FIRST SERVICE** - Explain the importance of the service at 500 km and the ongoing service schedule.

**PERIODIC MAINTENANCE** - Explain the need of the periodic maintenance and indicates that don't do the correct maintenance and services indicates can be cause to loose the warranty.



## DELIVERY OF THE MOTORCYCLE (PRE DELIVERY INSPECTION & HANDOVER)

### ADJUSTMENTS :

**MIRRORS** - Set to the correct position for the user.

**CLUTCH LEVER** - Adjust to suit.

**REAR BRAKE LEVER ADJUSTMENT** - Adjust to the correct height for the user.

**GEAR LEVER ADJUSTMENT**- Adjust to the correct height for the user.



**WARNING:** Changes on the bike don't authorized by RIEJU, or use of parts that don't are ORIGINAL SPARE PARTS from RIEJU on the warranty period. Release RIEJU from any responsibility on the damages produce on the bike and cancel the warranty.





## IDENTIFICATION OF THE MOTORBIKE

On the chassis you will find your motorbike's identification number engraved

The number is stamped on the right hand side of the front frame (Steering head.) is unique to every machine. This number is required to register your vehicle, this chassis or VIN number should be quoted when requesting warranty assistance or genuine Rieju spare parts.



## ENGINE IDENTIFICATION NUMBER

The engine serial number is located on the top, rear side bottom of the engine.

The engine number will serve as a reference when requesting spare parts from the dealership.

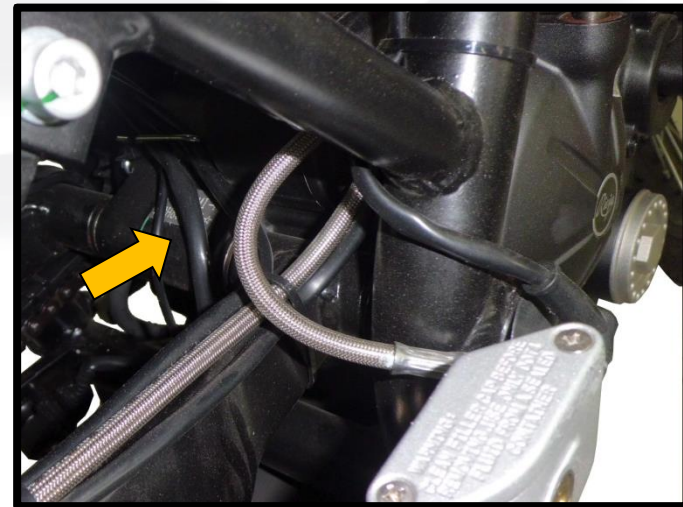



## MAIN ELEMENTS OF THE MOTORBIKE

### KEYS

With this model, you will be given a set of keys, which are used for the Ignition switch/Steering lock.

### HANDLE BAR SWITCHES

#### 1-. Indicator Switch

This has 3 positions: in the centre position it is deactivated, to indicate right it must be moved to the right and to indicate left it must be moved to the left.



**NOTE:** Note that the button always returns to the central position, to switch off the direction indicators push button.

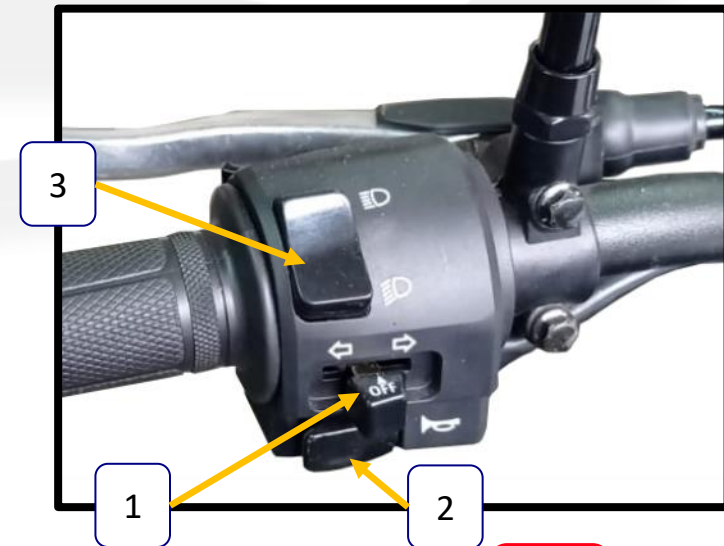



## 2-. Horn button

Press the button to activate the horn.

## 3-. Main and dip beam light switch

This switch has two positions: when it's down the dip beam is on and in the upper position the main beam is illuminated.

This model incorporates a bulb of 12V 60/55W H4 for light of main and dip beam and of 12V 5W for position light.



**CAUTION:** Use other type of bulb or change of power of it can cause damages on the optics of the vehicle.

This type of fault is exempt from warranty.



## CLUTCH LEVER

The clutch lever is situated on the left-hand side of the handlebar. To activate it, pull the lever towards the grip or handlebar.



## FRONT BRAKE LEVER

The front brake lever is situated on the right-hand side of the handlebar. To activate the front brake, pull the lever towards the handlebar.

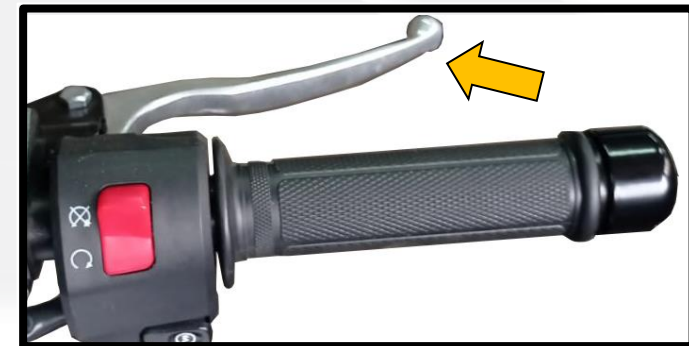

## REAR BRAKE PEDAL

The rear brake pedal is on the right-hand side of the motorbike. To activate it, press downwards with the foot.

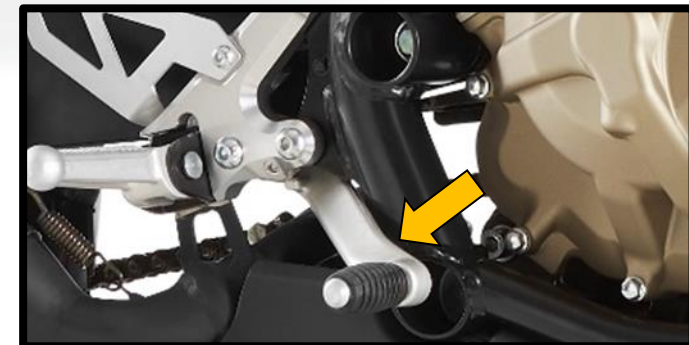



## GEAR BOX PEDAL

This is situated underneath the left part of the motor, it is activated with the foot taking it all the way and then letting it go back to its' original position before changing gear again. To put the motorbike into first gear, the pedal has to be pressed downwards. To change the other gears, lift the lever upwards with the toe.



## PETROL TANK

To get to the tank, open it using the stop- per of the tank, turning it anti-clockwise.

The capacity of the tank is 9,5 litres.



**CAUTION:** Use only Unleaded petrol E5, without oil, the use of another type of fuel can damage the engine and this damages will not be considered as warranty.





## ROUTINE TESTING

### Front brake

Pulling in the front brake lever operates the front brake by pumping brake fluid from the master cylinder to the front brake calliper. The brake pads are pushed by the calliper pistons against the front disc. Slowing the bike down.

The braking surface of the disc should be free of oil and dirt to ensure maximum braking efficiency. If for any reason the master cylinder is empty of brake fluid after checking for pad wear it should be topped up as necessary. If there is air in the system the brakes will need to be bled.



**WARNING:** Bled the braking system will do by one professional, Rieju recommend do this operation by your official RIEJU dealer.



## Rear brake

Periodically check the brake fluid level in the reservoir situated on top of the rear brake master cylinder and under the rear right hand panel, to top up.



**CAUTION:** If the reservoir is empty please go to your official RIEJU dealer.

## Brake fluid level and brake pad wear

Check that the level of brake fluid is correct, if not, Check for brake pad wear. If the pad material is less than 2mm thick, the pads should be replaced. If the pads are not worn out, top up the brake reservoir with brake fluid.

To access to rear reservoir you must disassembly right rear cover unscrew 3 nuts, as indicate on the image.



**WARNING:** Brake fluid is corrosive and will damage paintwork, if spilt wash off with water immediately.



**TIP:** Always remember that the above must be carried out by a RIEJU official service.

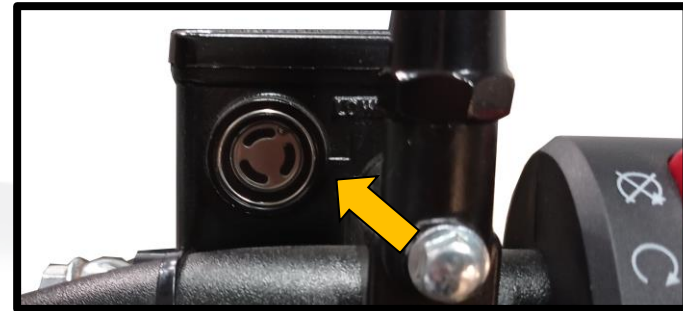



## Throttle twist grip (1)

Ensure it works correctly, by turning the grip and verifying if the free play is correct. The grip should return to closed position when released.

## Lights, indicators and warning lamps

Check operation of all lights, and direction indicators plus the oil warning lamp and petrol reserve panel lights. Replace bulbs as necessary.

## Start switch (2)

This switch is used to start the engine, after verifying that the gear-change pedal is in the neutral position.

## Kill switch (3)

This switch is used to stop the engine, when we use the kill switch only the engine will be stopped the rest of the electrical system is still powered (lights, horn, injection pump, etc).

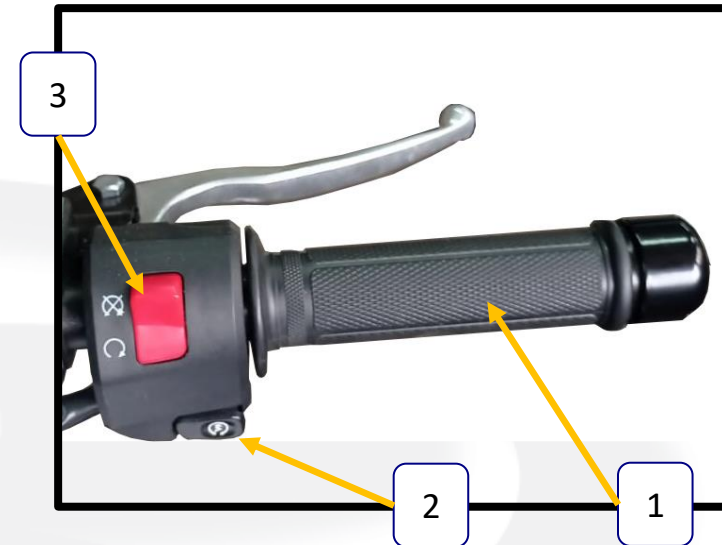





## Tyres

The tyre pressure directly effect the road holding ride comfort and braking distance, the, therefore check the tyre pressures regularly for your own safety.



**ADVICE:** Make sure that the rim is central and not damaged, as well as the wear on the tyres. Do not overload the vehicle as this will effect stability, and increases tyre wear.



**CAUTION:** when the pressure is very high, the tyres can no longer absorb any shocks, transmitting any road surface defects directly to the chassis, handlebar and rider.

## PRESSURES

	FRONT	REAR
<b>TYRE</b>	100-90-18 56 P	130/80-17 65P
<b>PRESSURE</b>	1,9 Kg/Cm <sup>2</sup> 190 kPa	2,1 Kg/Cm <sup>2</sup> 210 kPa



## INSTRUMENT AND INDICATORS

### 1.- Speedometer (Kmh and Mph)

### 2.- Out of gear (Neutral) indicator ( **N** )

This light comes on when the gear change lever is in the neutral (N) position, that is to say, out of gear.

### 3.- Temperature warning lamp ( )

This light is very important as it can tell us if there is an excessive increase in engine running temperature due to an engine fault or a low level of cooling liquid in the radiator.

 **ATTENTION:** Do not use the bike with this warning light on, as this may cause serious damage to the engine, consult your RIEJU dealer as soon as possible.

### 4.- Headlight Main beam light ( )

This indicator comes on when the headlights are on main beam.





### 5.- Fuel lamp ( )

The fuel level is below the reserve, fill up as soon as possible to prevent running out of fuel.

### 6.- Direction indicator warning lamp ( )

This indicator comes on when we activate the direction indicators.

### 7.- Engine warning lamp ( )

This indicator comes on when on fail is detected on the engine.

 **ATTENTION:** Consult your RIEJU dealer as soon as possible.

### 8.- Battery low Warning lamp ( )

This indicator comes on when the battery is low,.

 **ATTENTION:** Consult your RIEJU dealer as soon as possible.





## MOTORBIKE OPERATION

It is very important to know how to operate your vehicle correctly.



**ATTENTION:** Remember that you must not leave the motor running in an enclosed area, as the toxic gas from the exhaust could cause serious health problems.

## STARTING AND RIDING

Open the petrol tap. If the motor is cold, fully open the choke lever. Turn the ignition key one position clockwise and check the engine is in neutral, with the throttle closed press the starting button to turn the engine over. Pull in the clutch lever and put the motorbike in first gear (down one click), slowly release the clutch lever while at the same time accelerating slowly once moving allow the clutch lever to go its rest position (OUT) and ride away. Do not accelerate too much until the motor is warm enough



**ATTENTION:** Before riding the motor should be warm, never accelerate or ride hard when the motor is cold. This will prevent pre-mature damage to your engine.



## RUNNING IN

The most important period of your motorbike's life is between 0 and 500 kilometres and because of this we ask you to read the following instructions carefully. In the first 500 kilometres, the motorbike must not be overworked as the motor is new and the different parts of the motor have to wear in, until it works perfectly. During this period, avoid prolonged use of the motorbike at high revolutions or in conditions that could cause overheating.



**ATTENTION:** As indicate on the Service Manual you must done the first Service at 500 Km in your Official Rieju Workshop. Is essential done the services indicates on the Service Manual and enquire the signature and stamp of the Workshop at time to pick up the bike. Don't make the service as the Km indicates is reason for loss the vehicle warranty.

## ACCELERATION

Riding speed and acceleration is controlled by opening or closing the throttle. Operating the twist grip toward you increases the speed and away from decreases the engine revolutions.



## TO BRAKE (SLOWING DOWN)

Close the throttle; activate the front and rear brakes simultaneously, increasing the pressure progressively.



**WARNING:** Sudden braking can cause skidding.

## STOPPING

Close the throttle and activate both brakes simultaneously and when the vehicle has reduced speed, Pull in the clutch lever all the way. To stop the motor, switch off the ignition and remove key. Once the motor has stopped always close the petrol tap.

## GEAR BOX PEDAL

The Gear lever is located near the left hand engine case of the motor and is activated with the foot taking it all the way down or up, letting it come back to its' original position before changing gear again. To put the motorbike into first gear, the pedal has to be pushed downwards, to put in other gears lift the lever up as far as it will go with the toe. Gear changing should be done carefully to ensure the gear you want is selected before releasing the clutch.



## FRONT SUSPENSION

The front suspension consists of a hydraulic fork which has been crafted to the highest standards of technology and design.

- Upside down fork of  $\varnothing 40$  mm.



## REAR SUSPENSION

The rear suspension consists of two gas-assisted hydraulic shock absorber with separate gas reservoir and spring preload adjustment via the nut located on the shock absorber spring.





## COOLING SYSTEM

The radiator is mounted on the front of the motorbike below the headlamp; The radiator propose is to maintain a constant engine temperature by cooling the hot water which is pumped around the engine.



**ADVICE:** To check the level of coolant, undo the expansion tank cap and check that they has coolant, if it is dry carefully undo the radiator cap and top up until the middle of the expansion tank.



**CAUTION:** never open the top of the radiator when the motor is hot, because the boiling liquid could escape under the pressure, which is dangerous.

Use only antifreeze liquid. In this way we can avoid the water freezing causing damage to the water pump and water pipe ruptures. Do not top up with tap water as the calcium content could damage the radiator.







## CHECKING AND FILLING THE ENGINE OIL LEVEL

To check the oil level the engine will cold and the bike placed in horizontal position.

The oil level is indicated by the dip stick (A) oil, placed on the bottom right of the engine.

 **ADVICE:** Check oil level regularly.

Checking and filling the oil: Unscrew the dipstick (A) wipe the dipstick with a cloth and place back into the guide. Then remove it again. Check the engine oil level:

The oil level should be between the two top lines (b) minimum (a). Oil below advised level, fill to the correct level.

 **ADVICE:** See technical specifications to check the oil recommend by RIEJU.

 **WARNING:** Drive with the bike at minimum level (a) can damage the engine. The damages produce by this cause it will not admit as warranty.

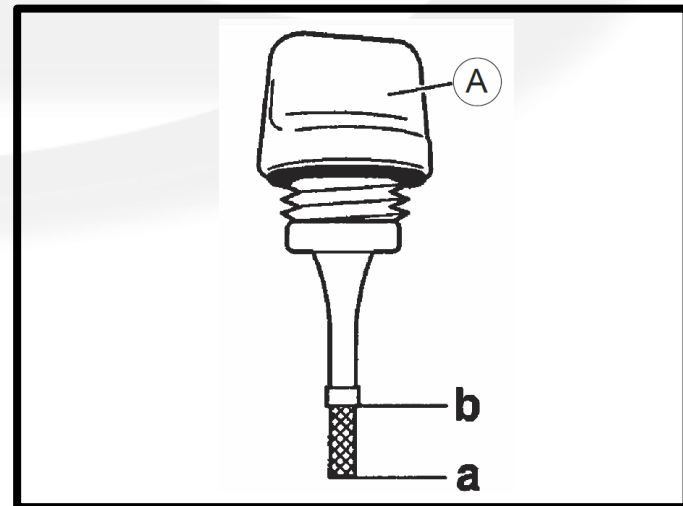



## CHAIN ADJUSTMENT AND TENSION

The motorcycle must be positioned vertically with its wheels on the ground firmly on the ground.

The chain must be adjusted to have a tolerance of 30 to 40 mm. At the midpoint between the output gear and the rear sprocket (see picture).



**ATTENTION:** The chain should be kept in perfect cleanliness and be properly lubricated each week.

To adjust to the correct tension you must perform these steps on both sides of the wheel:

- 1 - Set the gearbox in neutral and loosen the nuts (A) and (B).
- 2 - Using the bolts (C) adjust the chain tension, ensuring it is always the same distance on both sides of the axle. To do so use the rule marks on of the swing arm.
- 5 - Set the position using the 2 nuts (B) and tighten the nut (A) that secures the rear wheel axle

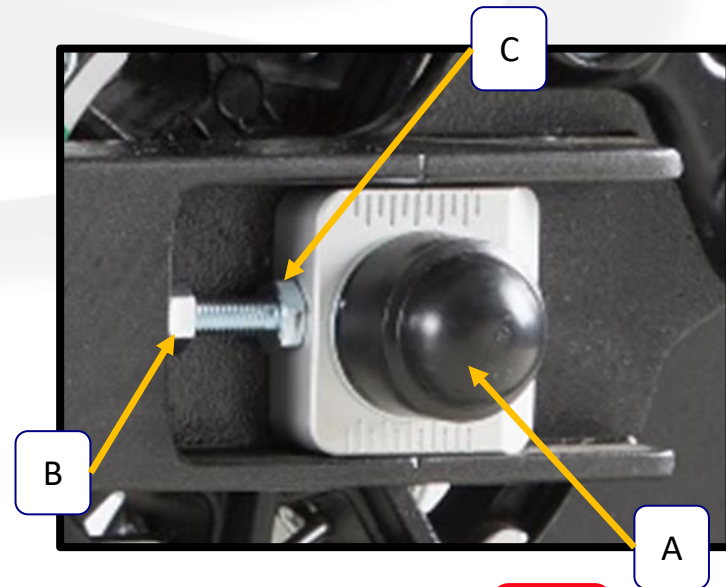
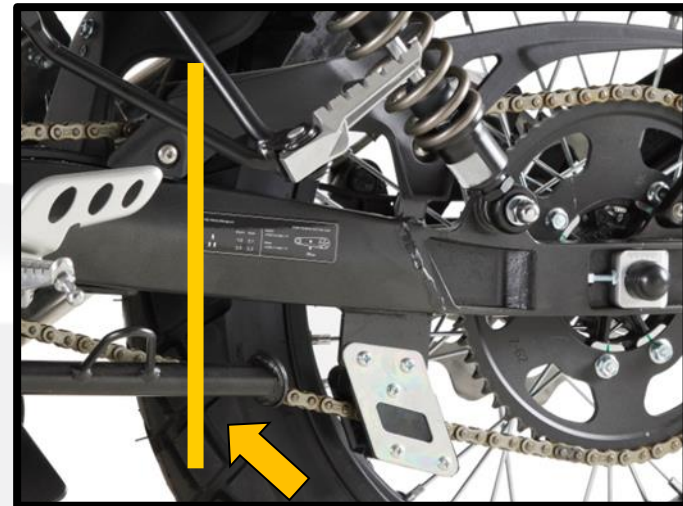



## CLEANING AND STORAGE

### CLEANING

Frequent and thorough cleaning of your motorbike will not only improve its performance and lengthen the useful life of its components but also emphasize the appearance of the motorbike. Order of cleaning:

- 1- Cover the exhaust pipe outlet/inlet to prevent water entering the system.
- 2- Check that the spark plug and all caps are firmly in place.
- 3- If the engine is very dirty apply a degreaser.



**ATTENTION: DO NOT** apply degreaser to the wheel axle, chain or brake discs.

- 4- Remove the degreasing agent along with the dirt using a low pressure water source such as a hosepipe.



**ATTENTION:** Rieju accepts no responsibility for the use of degreasing agents which stain and/or cause deterioration to the motorbikes components. Rieju accepts no responsibility for any possible damage resulting from the use of pressurized water to clean the motorbike. The carburettor provides the correct petrol air mixture to the engine. If the settings are tampered with poor performance and/or overheating may occur. If you have any problems please refer to your **RIEJU dealer**.



5- After all dirt has been washed off; the surfaces should be washed with warm water and mild detergent soap.

6- Remove any soap and with cold water and dry all surfaces. Clean the seat with vinyl upholstery cleaner.

7- Once cleaned, start the engine and allow it to idle for a few minutes, this will completely dry all the components and at the same time leave all connections moisture free.

## **LONG-TIME STORAGE**

For prolonged storage of the motorbike, it is advised that all cleaning procedures above are adhered to prevent any likelihood of deterioration. Once the motorbike has been thoroughly cleaned it can be readied for storage as follows:

1- Drain all fuel from the tank, pipes and the carburettor.

2- Lubricate all control cables.

3- Seal the exhaust pipe to prevent the entry of any moisture.

4- Remove the battery and charge at least once a month, be careful to ensure the battery is stored in the correct conditions.



## CHECKS BEFORE USING MOTORCYCLE

Check the following points before using your motorcycle

ITEMS TO BE CHECKED	CHECK-UP	IF NECESSARY...
Accelerator grip	Movement	Adjustment
Tyres	Pressure and wear	Pump up or replace
Battery	Charge level	Charge
Steering	The softness of the steering, the flexibility of the movement, that does not present slacks	
Lights and indicators Instrument panel	Work correctly Work correctly	Replace
Clutch	Smooth operation	Adjustment
Front and rear brakes Disc brakes	Brake pads for wear and test brakes Damages or dusty	Replace
Petrol tank	Level	Refill
Transmission chain	Tension and condition of chain and sprocket	Lubricate



**ATENCIÓN:** Each time the vehicle is used, it should be checked as above. If during these checks any abnormality is established, it should be repaired before using the motorcycle.



## TECHNICAL SPECIFICATIONS AND CHARACTERISTICS

COMPONENT	SPECIFICATIONS
<b>ENGINE</b>	
Type	4 stroke water cooled
Engine capacity	124 cm <sup>3</sup>
Model cylinders	1 inclined forwards
Piston size	47,0x58,0mm
Compression ratio	12,0:1
Starting system	Electrical
<b>PETROL</b>	
Type	Unleaded petrol E5 
<b>OIL FILTER</b>	
Type	Paper
<b>OIL PUMP</b>	
Type	Mechanic



COMPONENT	SPECIFICATIONS
<b>ENGINE OIL</b>	
Lubrication system	Autolube
Oil type	GRO GEAR SMART 10W40
Engine oil	1,2 l
When filter is not removed	1,0 l
when filter is removed	1,1 l
<b>WATER PUMP</b>	
Type	Mechanical
<b>SPARK PLUG</b>	
Type	NGK/CR9EB
Electrode Clearance	0,6-0,7mm

 **Advice:** Contact your authorized **RIEJU** workshop in case of any problem or breakdown of the vehicle.





## MAINTENANCE

MAINTENANCE OPERATIONS	500 Km	3500 km	6500 Km	9500 Km	12500 Km
Brake system checks	C	C	C	C	C
Transmission oil level checks * * Oil filter it will changed too	R	R	R	R	R
Chain tension and wear checks	C & L	C & L	C & L	R	C & L
Suspension Checks	C	C	C	C	C
Check, adjust and lubricate controls and cables	C	C	C	C	C
Cleaning and greasing of air filter	C & L	C & L	C & L	C & L	R
Oil Strainer	C	-	-	-	C
Inspect and adjust the sparkplug	C	C	R	C	R
Inspect all nuts and bolts for the chassis and plastics	C	C	C	C	C

C:CONTROL; R: REPLACEMENT; L:LUBRICATION; L=CLEANING





MAINTENANCE OPERATIONS	500 Km	3500 km	6500 Km	9500 Km	12500 Km
Check the electrical System	C	C	C	C	C
Valves adjustment		C	C	C	C
Inspect radiator liquid levels	C	C	C	C	R
Inspect exhaust system	C	C	C	C	C
Check terminals and battery condition	C	C	C	C	C
Check oil pump operation	C	C	C	C	C
Tyre	C	C	C	C	C

C:CONTROL; R: REPLACEMENT; L:LUBRICATION; L=CLEANING



**CAUTION:** Maintenance schedule can change on function of the bike use, conduction, environmental conditions, etc...



**RIEJU**®  
...for everyday adventure